

DL2523UC-MPY

f=25mm F2.3

**for 1/1.1 Type 12Megapixel cameras, Motorized Control Fixed-focal
USB interface, C-Mount**

Optical Specifications

Model No.		DL2523UC-MPY		Effective Lens Aperture		Front:φ19.6mm Rear:φ13.5mm	
Focal Length		25mm		Back Focal Length		14.3mm (in Air)	
Operation Range	Iris	F2.3 - F16.0		Flange Back Length		17.526mm (In Air)	
	Focus	0.12m - Inf.		Max. Image Circle		φ14.4mm	
Object Dimension at M.O.D.	1/1.1 Type	48.4mm x 35.5mm		Distortion	1/1.1 Type	0.1%	
	2/3 Type	38.0mm x 28.5mm			2/3 Type	-0.1%	
	1/1.8 Type	31.1mm x 23.3mm			1/1.8 Type	-0.1%	
Angle of View	D	1/1.1 Type	31.0°	2/3 Type	24.8°	1/1.8 Type	20.4°
	H	11.22mm x 8.22mm	25.3°	8.8mm x 6.6mm	20.0°	7.2mm x 5.4mm	16.4°
	V	(φ13.9mm)	18.7°	(φ11.0mm)	15.1°	(φ9.0mm)	12.3°

Mechanical & Electrical Specifications

Control Interface		USB2.0		Dimensions		As per the attached drawing	
Power mode		Bus powerd (500mA)		Mount		C-Mount	
Connector		USB TypeA		Weight		166g	
Operating Temperature		-20°C - +60°C		Tripod Screw		-	
Control	Iris	Motorized		Filter thread		M30.5 x P0.5mm	
	Focus	Motorized		IRCF switcher		-	

Dimensions

Unit:mm

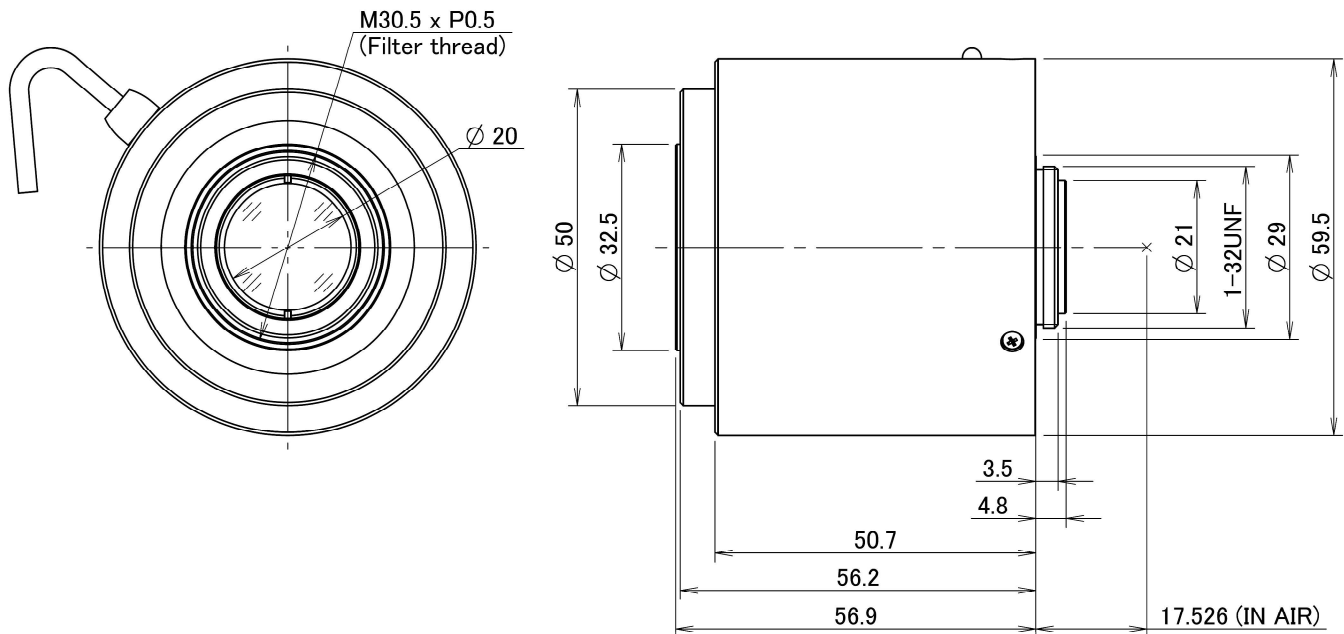

Length of Wire

300±20 (mm)